



Diamond Stone Honing Guide DWS/HG/SET

Please read carefully before use

DIAMOND STONE HONING GUIDE REF. DWS/HG/SET

Thank you for purchasing this Trend product, which should give lasting performance if used in accordance with these instructions.

The following symbols are used throughout these instructions.



Denotes risk of personal injury, loss of life or damage to the tool in case of non-observance of the instructions.

INTENDED USE

This product is intended to be used with a diamond bench whetstone of suitable size to hone a primary bevel angle on a bevel edge chisel or plane iron (blade).

Chisel blade width:	min. 10mm (3/8")
	max. 32mm (1-1/4")
thickness:	max. 7mm (0.275")
length:	min. 75mm (3") at 25°
	max. 60.3mm (2-3/8")
Plane Blade width:	max. 60.3mm (2-3/8")
Bench stone width:	min. 63mm (2-1/2")
Bench stone length:	min. 178mm (7")

SAFETY

Please read and understand these instructions before use.

PLEASE KEEP THESE INSTRUCTIONS IN A SAFE PLACE.

Please keep children away from tools and work area. Users must be competent in using

woodworking equipment before using our products.

Please consider work environment before use.



All cutting edges are very sharp and care must be taken to prevent injury.

Never sharpen blade towards the hand or body.

INTRODUCTION

The honing guide is to be used with the supplied stepped setting device. The setting device will not work with other makes and models of honing guide. The honing guide has self-centring clamping jaws, which clamp from the side and a wide roller for stability. It can be used to maintain a primary angle of 25°, 30°, 35° or 40°.



Honing guide cannot be used with Firmer chisels or short blade (Butt) chisels.

ITEMS REQUIRED

- Flat workbench.
- Fine grit diamond bench whetstone minimum size 63mm (2-1/2") wide x 178mm (7") long.
- Chisel or plane iron.
- Lapping fluid.
- Non-slip mat or bench holder for diamond whetstone.

ITEMS ENCLOSED & DESCRIPTION OF PARTS

- A. Honing guide **x1**
- B. Setting device **x1**
- C. Self-centring clamping jaw
- D. Clamping jaw notch datum
- E. Knurled thumbscrew
- F. Roller wheel
- G. Setting device 'V' groove
- H. Setting device steps/sight lines
- I. Setting device angle mark
- J. Instructions **x1**

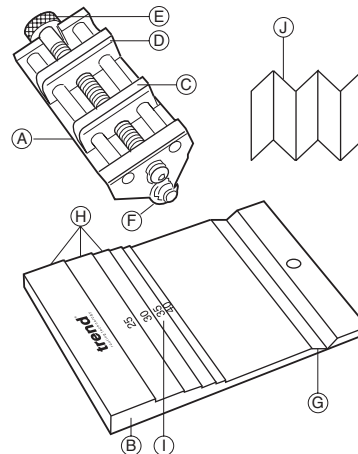

OPERATION

Lapping

The face (or bottom) of the blade needs to be flat before attempting to hone the bevel. Using a fine grit bench stone lap the face or bottom of the blade. The blade will not need to be lapped flat along the entire face.

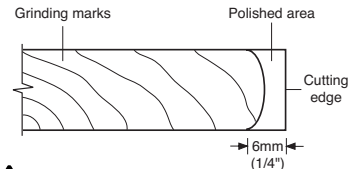
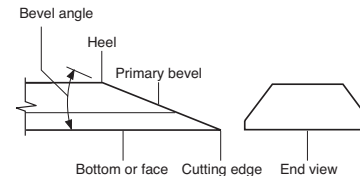

Keep the face of the blade flat when lapping, otherwise you could gouge the face or create a back bevel.



Ensure working height and position are comfortable.



ENVIRONMENTAL PROTECTION



Recycle raw materials instead of disposing as waste.

Packaging should be sorted for environmental-friendly recycling.

The product and its accessories at the end of its life should be sorted for environmental-friendly recycling.

GUARANTEE

All Trend products are guaranteed against any defects in either workmanship or material, except products that have been damaged due to improper use or maintenance.

© Trend Machinery & Cutting Tools Ltd. 2013 E&OE
® All trademarks acknowledged

Trend Machinery & Cutting Tools Ltd

Odhams Trading Estate St Albans Road
Watford WD24 7TR England
Tel: 0044(0)1923 249911
technical@trendm.co.uk
www.trend-uk.com



PTO



RECYCLABLE

trend[®]
routing technology

INST/DWS/HG v3.0

Fitting Blade to Honing Guide

- Place setting device on a non-slip flat surface, with the steps facing towards you.
- Select the required primary bevel angle that needs to be maintained on the tool.
- Rotate the knurled thumbscrew of the honing guide to adjust the clamping jaws to suit the tool to be honed.

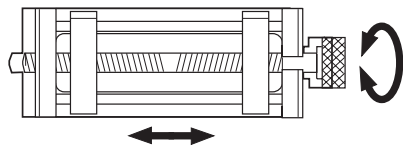

- Place the tool into the opening with the bevel of the blade facing down (face of blade uppermost). The blade will need to initially project about 35mm (1-3/8") from edge of guide.
- Position both the edges of the tool blade into the notches in the clamping jaws and up towards the notch datum surface.

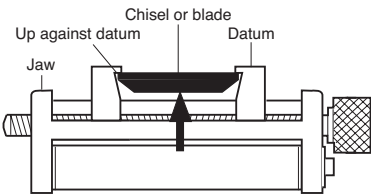

- Hold tool and allow honing guide to be supported by the tool. (This will ensure tool blade is against datum surface).

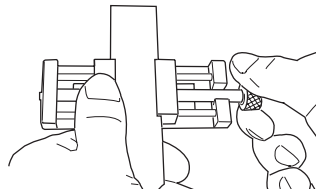

- Turn the knurled thumbscrew and lightly clamp the tool blade.

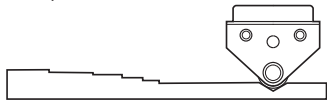

- Place honing guide onto the setting device, ensuring the roller is placed into the 'V' notch. The knurled thumbscrew can be either to the left or right.
- Carefully pivot the blade and honing guide assembly towards the steps of the setting guide. Slightly loosen the thumb knob and slide the blade until the end of the blade rests on the step of the chosen angle.

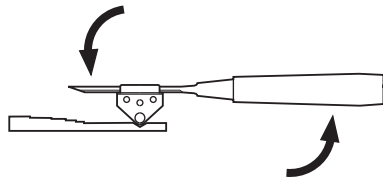

- For steeper angles slide blade forward until it touches the vertical stop. The blade does not need to be flat on step but the edge must be parallel to the step face.

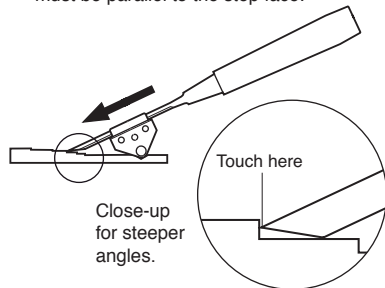

- For shallow angles the step is used as a sight line and not as a stop. Look down vertically on the blade and slide blade forward until the end of the blade is in line parallel with the sight line.

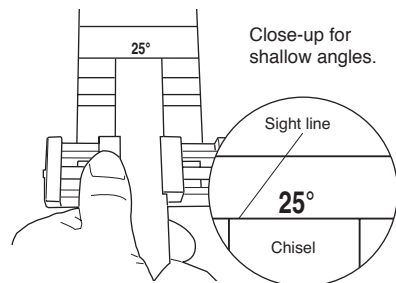

- Tighten knurled thumbscrew to hold blade. A large slotted screwdriver can be used in the slot on the knurled thumbscrew to aid tightening.
- One jaw has a convex surface so the blade is clamped securely. Please note there will be a small amount of play between jaws, body and roller.
- Reverse the honing guide out of the 'V' notch.



The primary angle required is the printed angle that is visible on the setting device when the tool is placed against the step or sight line.

HONING THE PRIMARY BEVEL

- Place the diamond stone onto a flat surface. A non-slip mat or a bench holder should be used to keep the stone from moving.
- Spray lapping fluid onto the diamond stone.
- Place honing guide with blade fitted onto the diamond whetstone.
- Swing assembly forward until the blade touches the surface of the stone.



The honing guide and setting device can only be used to maintain an existing angle.



Periodically check thumb screw is tight when in use.

- Roll the honing guide with blade fitted back and forth until a satisfactory bevel is formed, ensuring any downward force is applied mainly to the edge of the blade.

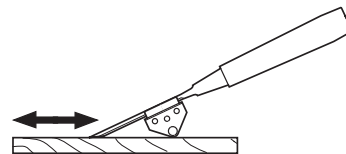

- The roller on the honing guide should be in contact with the stone at all times.
- Un-tighten knurled thumbscrew to release blade. A large slotted screwdriver can be used in the slot on the knurled thumbscrew to aid loosening.

HONING A SECONDARY ANGLE

- Firstly maintain the primary angle, then reset the tool to the next greater angle e.g. 25° to 30°.
- Follow the instructions shown for the primary angle.

After use store accessory carefully.



Regularly vacuum clean and oil roller to ensure it rotates freely, otherwise mechanism could seize.

SPARE PARTS

Please use only Trend original spare parts and accessories.

Item	Qty.	Desc.	Ref. (1 off)
A	1	Diamond Whetstone Honing Guide	DWS/HG/01
B	1	Diamond honing guide setting device	DWS/HG/02
C	1	Instruction	INST/DWS/HG

MAINTENANCE

The accessory has been designed to operate over a long period of time, with the minimum amount of maintenance.

Continual satisfactory operation depends upon proper tool care and regular cleaning.

Cleaning

- Regularly clean with a soft cloth.
- The product is exposed to abrasive particles in use, so the roller and clamping threads should be vacuumed to remove particles, otherwise the grit could foul the mechanism and could cause a flat to be ground on the roller.

Lubrication

- The roller on the honing guide needs to be oiled regularly as the roller can be exposed to water and lapping fluid in use.

Storage

- Always return product to its packaging after use.