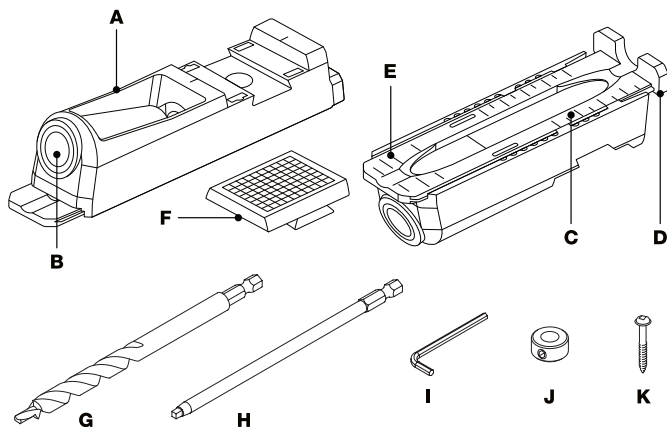




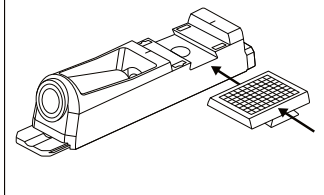
# PH/JIG/BS

<b>EN</b>	<i>Original Instructions</i>	P.3
<b>DE</b>	<i>Übersetzung Der Originalanleitung</i>	P.7
<b>FR</b>	<i>Traduction Des Instructions Originales</i>	P.11
<b>NL</b>	<i>Vertaling Van De Originele Instructies</i>	P.15
<b>DK</b>	<i>Oversættelse Af De Originale Instruktioner</i>	P.19
<b>SE</b>	<i>Översättning Av De Ursprungliga Instruktionerna</i>	P.23
<b>NO</b>	<i>Oversettelse Av De Originale Instruksjonene</i>	P.27
<b>FI</b>	<i>Alkuperäisten Ohjeiden Suomennos</i>	P.31

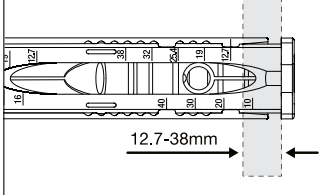




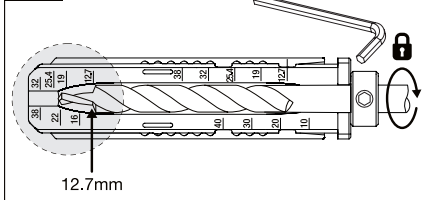
**Fig.1**



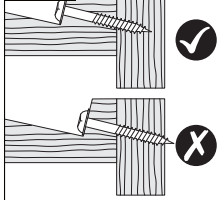
**Fig.2**



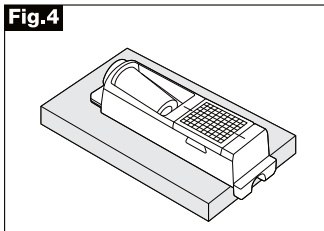
**Fig.3**



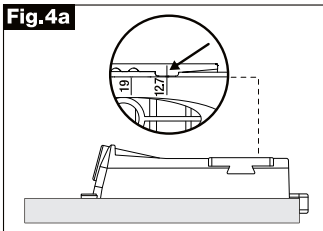
**Fig.3a**



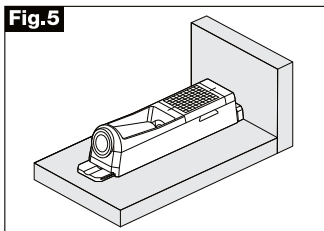
**Fig.4**



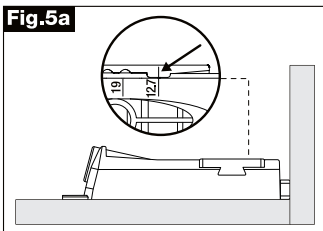
**Fig.4a**



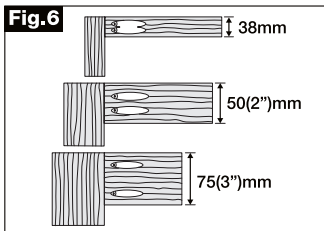
**Fig.5**



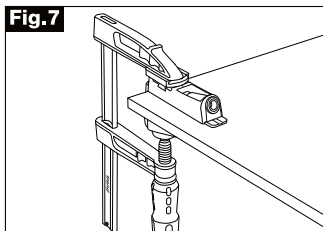
**Fig.5a**



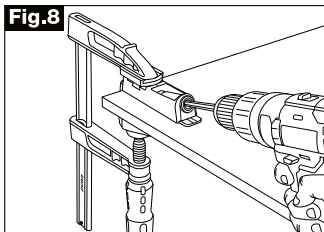
**Fig.6**



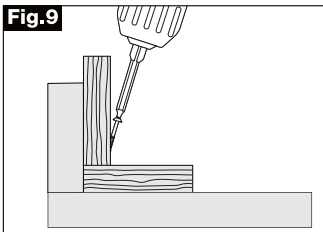
**Fig.7**



**Fig.8**



**Fig.9**



## EN - SINGLE POCKET HOLE JIG

Dear Customer,

Thank you for purchasing this Trend product, which should give lasting performance if used in accordance with these instructions.

### TECHNICAL DATA

Material thickness:	Min. 12.7mm
	Max. 38mm
Material width:	Min. 38mm
Drill bit size:	9.5mm

The following symbols are used throughout this manual.



Denotes risk of personal injury, loss of life or damage to the tool in case of non-observance of the instructions.



Refer to the instruction manual of your power tool.

This unit must not be put into service until it has been established that the power tool to be connected to this unit is in compliance with 2006/42/EC (identified by the CE marking on the power tool).

### INTENDED USE

This accessory is to be used with a drill with minimum 10mm chuck capacity to allow pocket hole jointing of softwoods and hardwoods.

### SAFETY

Please read and understand the safety points in these instructions as well as your power tool instructions.

### PLEASE KEEP THESE INSTRUCTIONS IN A SAFE PLACE

#### Safety Points

1. Disconnect power tool attachment from power supply when not in use, before servicing, when making adjustments and when changing accessories such as cutters. Ensure switch is in "off" position and cutter has stopped rotating.
2. Read and understand instructions supplied with power tool, attachment and cutter.
3. Current Personal Protective Equipment (PPE) for eye, ear and respiratory protection must be worn. Keep hands, hair and clothes clear of the cutter.
4. Before each use check cutter is sharp and free from damage. Do not use if cutter is dull, broken or cracked or if any damage is noticeable or suspected.
5. The maximum speed (n<sub>max</sub>) marked on tool or in instructions or on packaging shall not be exceeded. Where stated, the speed range should be adhered to.
6. Check all fixing and fastening nuts, bolts and screws on power tool, attachment and cutting tools are correctly assembled, tight and to correct torque setting before use.
7. Ensure all visors, guards and dust extraction is fitted.
8. Do not switch power tool on with the cutter touching the workpiece.
9. Trial cuts should be made in waste material before starting any project.
10. Repair of tools is only allowed according to tool manufacturers instructions.
11. Do not take deep cuts in one pass, take shallow passes to reduce the side load applied to the cutter.

12. User must be competent in using woodworking equipment before using our product.
13. Consider working environment before using tools. Ensure working position is comfortable and component is clamped securely. Keep proper footing and balance at all times.
14. Please see children and visitors away from tools and work area.
15. All tools have a residual risk so must therefore be handled with caution.

If you require further safety advice, technical information, or spare parts, please call Trend Technical Support or visit [www.trend-uk.com](http://www.trend-uk.com)

### **POCKET HOLE CONCEPT**

A pocket hole involves clamping one piece of the material to be joined to the jig and boring one or two counter-bored holes with a special stepped drill. This piece of material is joined to the other piece and assembled with self-tapping screws. Once driven into the material will provide a strong joint is made.

The screw removes the need for clamping during the gluing process. The component can be handled whilst the glue is drying. The jig can be adjusted to suit different thicknesses of material, to keep the screw centred in the workpiece to ensure a good joint.

### **ITEMS ENCLOSED & DESCRIPTION OF PARTS**

- A** Body
- B** Drill guide
- C** Material thickness scale
- D** Slide adjuster
- E** Drill depth setting guide
- F** Clamp pad
- G** Drill bit
- H** Screwdriver bit
- I** Hex key
- J** Collar
- K** Self tapping screws

### **ITEMS REQUIRED**

- Drill
- Hand tools

**OPERATION**



- Assembly (fig. 1)
- Measuring the thickness of the workpiece (fig. 2)
- Setting the drill bit depth (fig. 3 & fig. 3a)
- Adjusting jig position (fig. 4 & fig. 5)
  - For standard work, slide adjuster face down (fig. 4a)
  - For repair work, set up slide adjuster face up (fig. 5a)
- Pocket hole spacing (fig. 6)
- Clamping (fig. 7)
- Drilling the pocket hole (fig. 8)
- Assembling the joint (fig. 9)




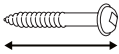
**Do not push hard on the drill until the drill pilot tip of the drill bit is fully into the work piece and the counterbore section is actually cutting. Use a high drilling speed to increase drill life (2000 rpm or higher). Keep the drill bit sharp.**

**Make sure drill bit is held in chuck securely. If the drill spins loose in the chuck the shock can break the drill bit tip. Place the drill bit into the top section of the drill guide hole before spinning. Do not place the drill tip against the component until the drill is at full speed.**



**Before using the pocket hole jig for the first time, it is recommended that a number of trial cuts are made in waste timber as this will allow the drill to bed into the drill guide bushes in the columns. During the bedding in process there will be evidence of some metal swarf.**

**When changing material or joint application, test the depth of the drill and collar before drilling into the workpiece. Test drill in waste pieces of the same thickness. Then drill a screw into the pocket joint only and lay it against the jointing piece to see if screw depth is correct.**

	
12.7mm (1/2")	25mm (1")
19mm (3/4")	30mm (1 1/4")
25.4mm (1")	37mm (1 1/2")
32mm (1 1/4")	50mm (2")
38mm (1 1/2")	63mm (2 1/2")

**MAINTENANCE** 

Please use only Trend original spare parts and accessories. The accessory has been designed to operate over a long period of time with minimum of maintenance. Continual satisfactory operation depends upon proper tool care and regular cleaning.

**Cleaning**

- Regularly clean with a soft cloth.
- Keep the threads clear of resin build up.

**Lubrication**

- Your accessory requires no additional lubrication.

**Storage**

- Always return product to its original packaging.

**Spare Parts**

- See website for details.

**ENVIRONMENTAL PROTECTION** 

Recycle raw materials instead of disposing as waste.

Packaging should be sorted for environmental-friendly recycling.

The product and its accessories at the end of its life should be sorted for environmental-friendly recycling.

**GUARANTEE**

All Trend products guaranteed against any defects in either workmanship or material, except products that have been damaged due to improper use or maintenance.

© Copyright 2019

No part of this publication may be reproduced, stored or transmitted in any form with prior permission. Our policy of continuous improvement means that specifications may change without notice. Trend Machinery & Cutting Tools Ltd. cannot be held liable for any material rendered unusable, or for any for of consequential loss. E&OE.