

JET

719AS

WOODWORKING MORTISER

719AS.....708572KM ...1~230V, 50Hz

PARTS LIST

JPW (Tool) AG

Tämperlistrasse. 5
CH-8117 Fällanden
Switzerland

Phone +41 44 806 47 48

Fax +41 44 806 47 58

www.jettools.com



P-708572KM 2014-06

719AS Mortiser Assembly

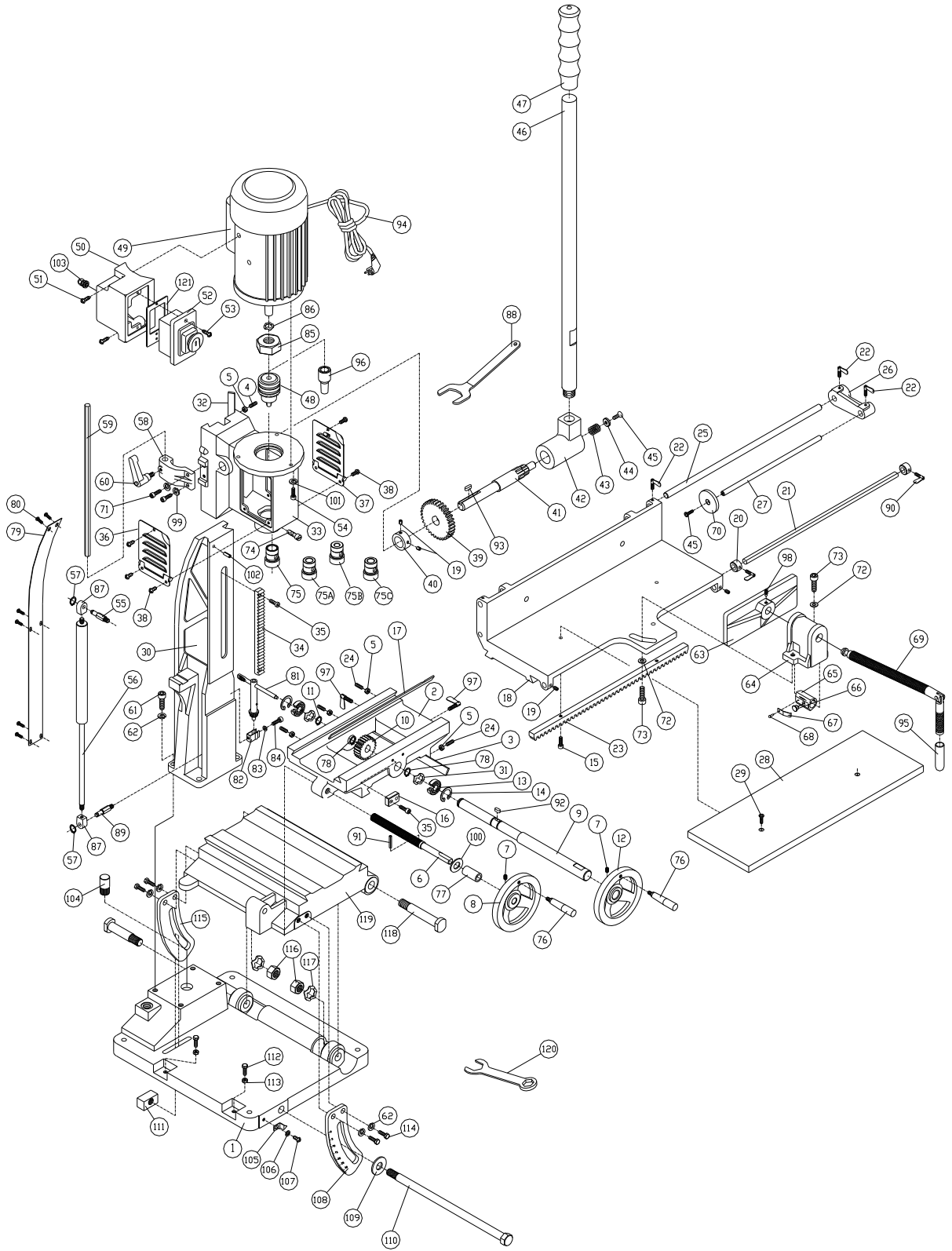

719AS Mortiser Assembly

Index No.	Part No.	Description	Size	Qty
	708572KM	719AS Mortiser Assembly (Items 1 thru 121)		1
1	719AS-101	Fixed Base		1
2	719AS-102	Base, Middle		1
3	6294126	Gib		1
4	TS-1523061	Socket Set Screw	M6x20	3
5	TS-1540041	Hex Nut	M6	9
6	6294129	Lead Screw		1
7	TS-1523031	Socket Set Screw	M6x10	4
8	6294131	Hand wheel		1
9	6294132	Shaft		1
10	6294133	Gear		1
11	6294134	C-Clip		1
12	6294135	Hand wheel		1
13	BB-600ZZ	Bearing	600ZZ	2
14	6294137	C-Clip		2
15	TS-1503041	Socket Head Cap Screw	M6x16	2
16	6294139	Stop Block		1
17	6294140	Gib		1
18	719AS-118	Main Table		1
19	TS-1523011	Socket Set Screw	M6x6	4
20	6294143	Setting Collar		2
21	6294144	Setting Rod		1
22	6294145	Wing Screw	M6x16	3
23	6294146	Rack		1
24	TS-1523071	Socket Set Screw	M6x25	6
25	6294148	Rear Length Setting Rod		1
26	719AS-126	Setting Length Block		1
27	6294150	Front Length Setting Rod		1
28	6294151	Wooden Table Insert		1
29	TS-2286201	Machine Screw, Flat Head, Phillips	M6x20	2
30	719AS-130	Column		1
31	6294154	Wave Washer		2
32	6294155	Gib		1
33	719AS-133	Headstock		1
34	719AS-134	Rack		1
35	TS-1503031	Socket Head Cap Screw	M6x12	4
36	719AS-136	Left Side Cover		1
37	719AS-137	Right Side Cover		1
38	TS-1533042	Machine Screw, Pan Head, Phillips	M5x12	4
39	6294162	Gear		1
40	6294163	Collar		1
41	6294164	Gear Shaft		1
42	719AS-142	Handle Hub (Clutch Block)		1
43	6294166	Spring		1
44	6294167	Washer		1
45	TS-1514021	Socket Head Flat Screw	M6x16	2
46	6294169	Handle		1
47	6294170	Handle Grip		1
48	6294171	Chuck	1/2" & Key	1
49	6294172E	Motor, 1HP, 1PH, 230V		1
	6294172E-SC	Start Capacitor (not shown)	200MFD/125VAC	1
	6294172E-RC	Running Capacitor (not shown)	30uf/250VAC	1
	6294172MF	Motor Fan (not shown)		1
	6294172MFC	Motor Fan Cover (not shown)		1

719AS Mortiser Assembly

Index No.	Part No.	Description	Size	Qty
50	6294173	Switch Box		1
51	TS-081C052	Machine Screw, Pan Head, Phillips	#10-24 x 3/4	2
52	6294175E	Magnetic Switch		1
53	TS-0749042	Tapping Screw, Pan Head, Phillips	#8 x 5/8	2
54	TS-1503051	Socket Head Cap Screw	M6x20	3
55	6294178	Upper Cylinder Fitting		1
56	719AS-156	Hydraulic Cylinder		1
57	6294180	C-Clip		2
58	719AS-158	Depth Setting Block		1
59	719AS-159	Depth Setting Rod		1
60	6294183	Universal Handle		1
61	TS-1505041	Socket Head Cap Screw	M10x30	4
62	TS-2361101	Lock Washer	M10	8
63	719AS-163	Clamping Jaw		1
64	719AS-164	Clamping Block		1
65	6294188	Rapid Nut		1
66	6294189	Friction Toe		1
67	6294190	Spring		1
68	6294191	Rivet		1
69	6294192	Locking Screw		1
70	6294193	Stop Disc		1
71	TS-1504051	Socket Head Cap Screw	M8x25	2
72	TS-1550061	Flat Washer	M8	2
73	TS-1504061	Socket Head Cap Screw	M8x30	2
74	6294197	Chisel Locking Screw		1
75	6294198E	Bushing	3/4"	1
75A	6294221E	Bushing	5/8"	1
75B	6294222E	Bushing	13/16"	1
75C	6294224E	Bushing	1-3/16"	1
76	6294199	Wheel Handle		2
77	6294200	Collar		1
78	6294201	E-Clip		2
79	6294202	Back Cover		1
80	TS-1532032	Machine Screw, Pan Head, Phillips	M4 x 10	6
81	6294204	Chuck Key		1
82	6294205	Chuck Key Holder		1
83	TS-2361051	Lock Washer	M5	1
84	TS-1502011	Socket Head Cap Screw	M5 x 8	1
85	6294208	Chuck Release Nut		1
86	6294209	Wave Washer		1
87	6294240	Cylinder Holder		2
88	6294211	Wrench (Chuck Removal)		1
89	6294212	Lower Cylinder Fitting		1
90	6294213	Wing Screw	M6 x 8	2
91	6294214	Roll Pin		1
92	6294215	Key	5 x 5 x 10	1
93	6294216	Key	5 x 5 x 12	1
94	6294217E	Power Cord(VDE)	230V,50Hz	1
95	6294223	Plastic Handle Sleeve		1
96	3005069	Chuck Extension Adaptor		1
97	719A-97	Wing Screw	M6x25	2
98	TS-0267051	Socket Set Screw	1/4-20 x1/2	2
99	TS-2361081	Lock Washer	M8	2
100	TS-2360121	Flat Washer	M12	1

719AS Mortiser Assembly

Index No.	Part No.	Description	Size	Qty
101	TS-2361061	Lock Washer	M6	3
102	6294243	Roll Pin	M6 x 16	1
103	719A-103E	Cord Strain Relief (VDE-PG11)		1
104	719A-108	Pin		1
105	719AS-1105	Pointer		1
106	TS-1550041	Flat Washer	M6	1
107	TS-1534032	Machine Screw, Pan Head, Phillips	M6 x 10	1
108	719AS-1108	Tilting Bracket		1
109	TS-155010	Flat Washer	M16	1
110	719AS-1110	Shaft		1
111	719AS-1111	Square Nut		1
112	TS-1490051	Hex Cap Screw	M8 x 30	2
113	TS-1540061	Hex Nut	M8	2
114	TS-1491021	Hex Cap Screw	M10 x 20	4
115	719AS-1115	Tilting Bracket		1
116	TS-2342161	Hex Nut, Nylon Lock	M16	2
117	719AS-1117	Wave Washer		2
118	719AS-1118	Bolt		2
119	719AS-1119	Tilting Base		1
120	719AS-1120	Box Wrench	23mm	1
121	719A-104E	Switch Plate		1

719AS Mortiser Stand Assembly

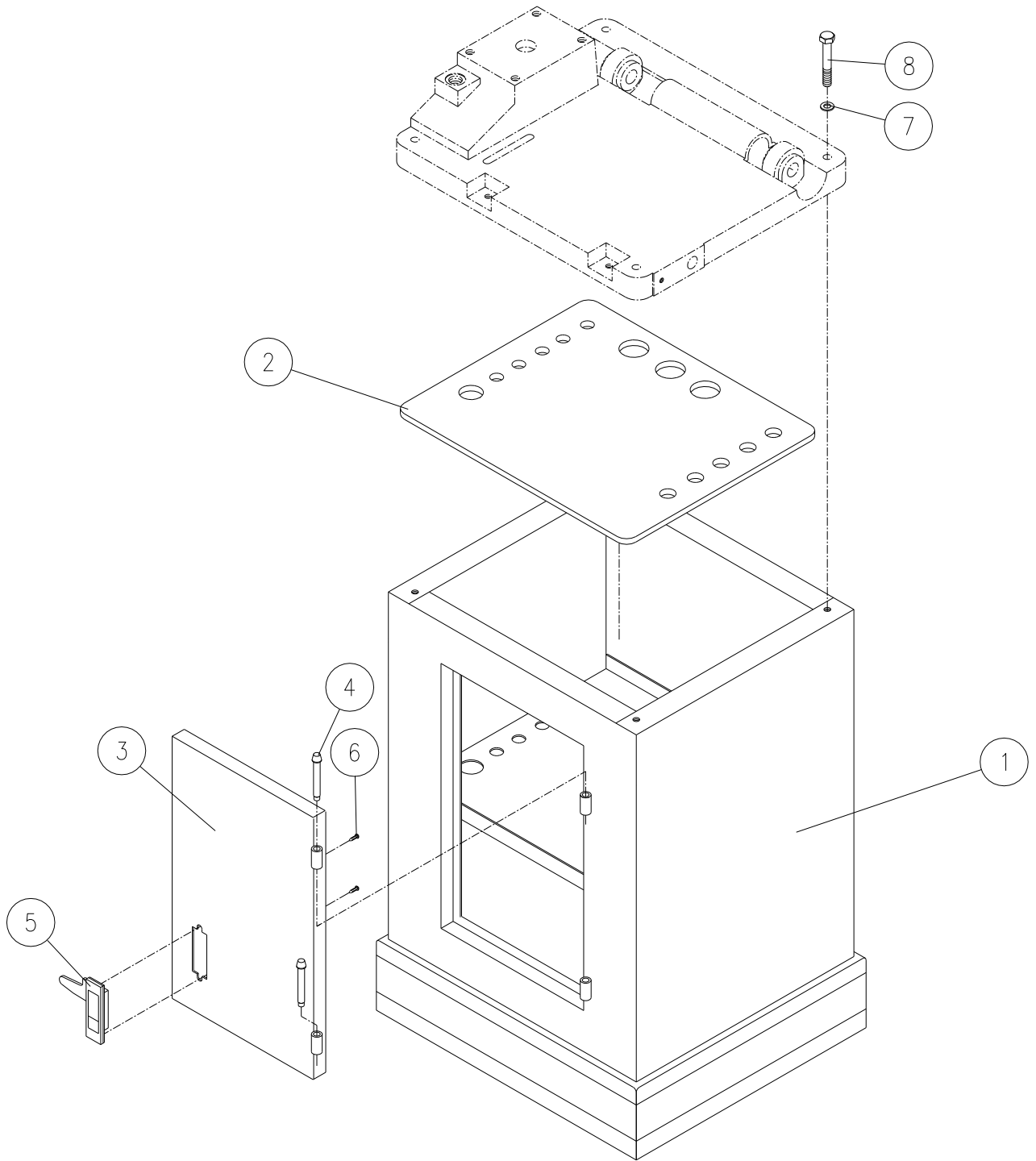

719AS Mortiser Stand Assembly

Index No.	Part No.	Description	Size	Qty
.....	708572S	Stand Assembly (Items 1 thru 8)		1
1.....	719AS-201	Stand		1
2.....	719AS-202	Shelf Cushion		1
.....	719AS-203A	Door Assembly (Items 3 thru 6)		1
3.....	719AS-203	Door		1
4.....	6294227	Pin		2
5.....	6294228	Door Latch		1
6.....	TS-2171012	Machine Screw, Pan Head, Phillips	M4 x 6	2
7.....	TS-2361081	Lock Washer	M8	4
8.....	TS-1490081	Hex Cap Screw	M8 x 45	4

719AS Workpiece Hold Down Assembly (Optional)

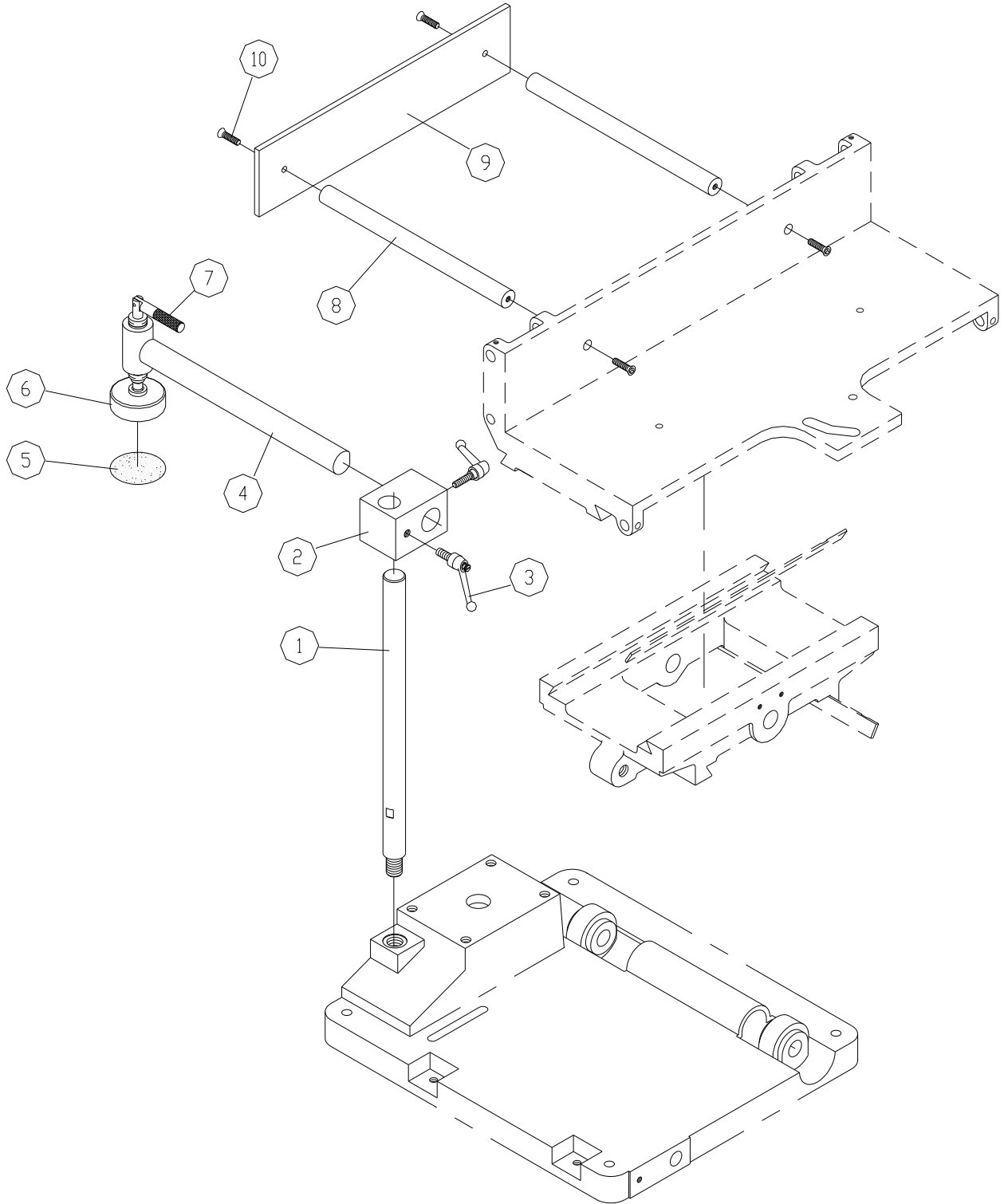

719AS Workpiece Hold Down Assembly (Optional)

Index No.	Part No.	Description	Size	Qty.
1.....	23045006.....	Fix Shaft.....		1
2.....	23045005.....	Fix Shaft bracket.		1
3.....	42011101.....	Lock Handle		2
4.....	23045003.....	Hold Down Shaft		1
5.....	23045004.....	Abrasive		1
6.....	33015004.....	Hold Down		1
7.....	23045007.....	Lock Handle		1
8.....	23045002.....	Fix Shaft.....		2
9.....	23045001.....	Fence.....		1
10.....	50108007.....	Pan Head Screw	M6 x 20	4

-

719AS.....708572KM ...1~230V, 50Hz

	colour of strands	Litzenfarben	couleur des cordons
BK	black	schwarz	noir
WH	white	weiß	blanc
BU	blue	blau	bleu
YE	yellow	gelb	jaune
RD	red	rot	rouge
BN	brown	braun	brun
GY	grey	grau	gris
GNYE	green-yellow	grün-gelb	vert-jaune
OG	orange	orange	orange
VT	violet	violett	violet

	meaning of symbol	Bedeutung der Zeichen	interprétation
M	motor	Motor	moteur
S	switch	Schalter	interrupteur
C	condenser	Kondensator	condensateur
E	electronic unit	Elektronik Einheit	unité électronique
F	fuse	Sicherung	fusible
RS	reversing switch	Drehrichtungsschalter	commu. droite/gauche
CS	centrifugal switch	Fliehkraftschalter	déclencheur centrifuge
OL	overload cut-off	Überlastschuttschalter	déclencheur surcharge
LS	limit switch	Positionsendschalter	micro

