

## DRS 68 Set 1/2"

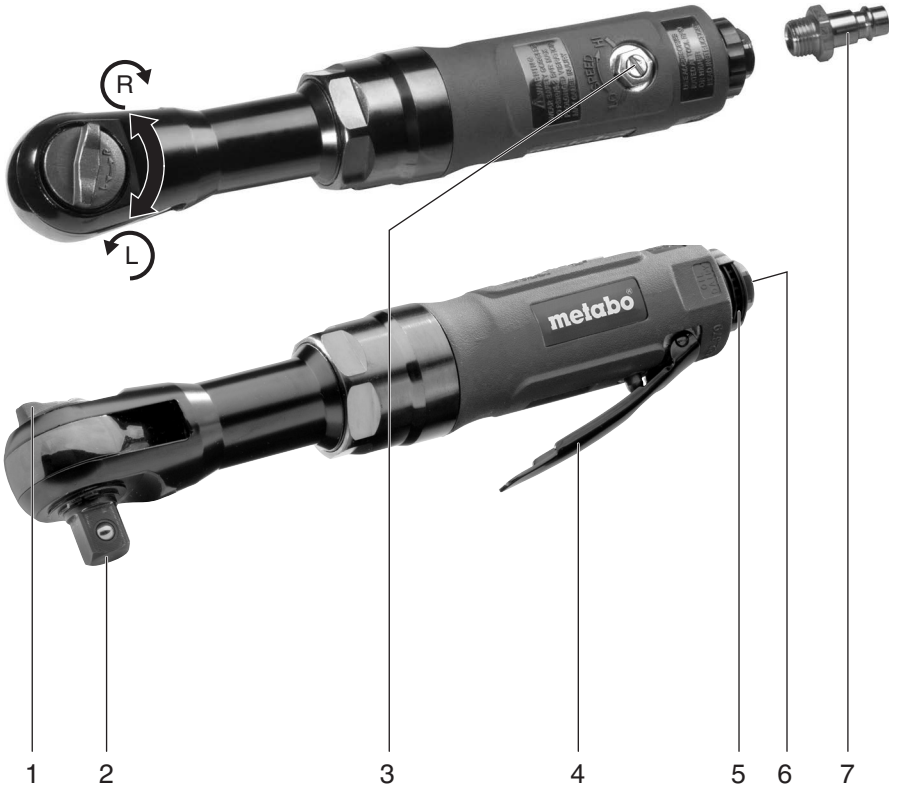

---

<b>de</b>	Originalbetriebsanleitung	4	<b>no</b>	Originalbruksanvisning	34
<b>en</b>	Original instructions	9	<b>pl</b>	Instrukcja oryginalna	38
<b>fr</b>	Notice d'utilisation originale	14	<b>hu</b>	Eredeti használati utasítás	43
<b>nl</b>	Oorspronkelijke gebruiksaanwijzing	19	<b>ru</b>	Оригинальное руководство по эксплуатации	48
<b>es</b>	Manual original	24	<b>cs</b>	Originální návod k použití	54
<b>fi</b>	Alkuperäinen käyttöohje	29			

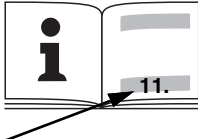

		<b>DRS 68 Set 1/2“</b> *1) 04119..
<b>V<sub>1</sub></b>	<b>l/min</b>	220
<b>p<sub>max.</sub></b>	<b>bar</b>	6,2
<b>n<sub>0</sub></b>	<b>./min</b>	175
<b>H</b>	<b>in</b>	1/2
<b>S</b>	<b>-</b>	M 13
<b>T<sub>max,R</sub></b>	<b>Nm</b>	68 (600)
<b>T<sub>max,L</sub></b>	<b>Nm</b>	68 (600)
<b>d<sub>i</sub></b>	<b>mm (in)</b>	10 (3/8)
<b>C</b>	<b>“</b>	1/4
<b>A</b>	<b>mm</b>	265 x 44 x 53 (10 7/16 x 1 3/4 x 2 3/32)
<b>m</b>	<b>kg (lbs)</b>	1,2 (2.6)
<b>a<sub>H</sub>/K<sub>H</sub></b>	<b>m/s<sup>2</sup></b>	7 / 1,5
<b>L<sub>pA</sub>/K<sub>pA</sub></b>	<b>dB(A)</b>	83 / 3
<b>L<sub>WA</sub>/K<sub>WA</sub></b>	<b>dB(A)</b>	87 / 3



\*2) 2006/42/EC

\*3) EN ISO 12100:2010, EN ISO 11148-6:2012

2023-01-17, Bernd Fleischmann

Direktor Produktentstehung & Qualität (Vice President Product Engineering & Quality)

\*4) Metabowerke GmbH - Metabo-Allee 1 - 72622 Nuertingen, Germany

ppa. B.F.

# Original instructions

## 1. Declaration of Conformity

We declare under our sole responsibility: These compressed air ratchet wrenches, identified by type and serial number \*1), comply with all relevant requirements of the directives \*2) and standards \*3). Technical file at \*4) - see page 3.

### For UK only:

**UK** We as manufacturer and authorized person to **CA** compile the technical file, see \*4) on page 3, hereby declare under sole responsibility that these compressed air ratchet wrenches, identified by type and serial number \*1) on page 3, fulfill all relevant provisions of following UK Regulations S.I. 2008/1597 and Designated Standards EN ISO 12100:2010, EN ISO 11148-6:2012

## 2. Specified Use

This air tool is designed to insert and extract screws for professional applications.

The tool must only ever be operated with a compressed air supply. The maximum supply pressure specified on the air tool must never be exceeded. The air tool must not be operated using explosive, inflammable or hazardous gases. It must not be used as a lever, crushing tool or striking tool.

Any other use does not comply with the intended purpose. Unspecified use, modification of the air tool or use of parts that have not been tested and approved by the manufacturer can cause unforeseeable damage.

The user bears sole responsibility for any damage caused by improper use.

Generally accepted accident prevention regulations and the enclosed safety information must be observed.

## 3. General safety instructions



For your own protection and for the protection of your air tool, pay attention to all parts of the text that are marked with this symbol!



**WARNING** – Reading the operating instructions will reduce the risk of injury.



**WARNING Read all safety warnings and instructions.** Failure to follow all safety warnings and instructions may result in electric shock, fire and/or serious injury.

**Keep all safety instructions and information for future reference.**

Pass on your air tool only together with these documents.

- The user or the user's employer must evaluate the specific risks associated with each application of the tool.
- The Safety Instructions must be read and understood before installing, operating, repairing or

maintaining the tool, and also before replace any accessory parts or carrying out any work in the vicinity of the air tool. Failure to read and follow the instructions may lead to serious injury.

- Only qualified, trained operators are authorized to install, adjust or use the air tool.
- The air tool must not be modified. Any modifications may reduce the efficiency of the safety measures and increase risks for the operator.
- Never use air tools that have been damaged. Look after your air tools carefully. Regularly check that all moving parts are functioning correctly without jamming, ensure that no parts are broken or damaged to an extent that they affect the operation of the air tool. Check that all signs and labels are legible and intelligible. Have damaged parts repaired or replaced before using the tool. Many accidents are caused by poorly maintained air tools.

## 4. Special Safety Instructions

### 4.1 Risks associated with ejected parts

- Disconnect the air tool from the compressed air supply before replacing the accessory or accessory parts, and also before carrying out repairs or settings.
- If either the workpiece, accessory parts or the air tool breaks, parts may be ejected at high speed.
- While operating, maintaining or repairing the air tool, or replacing accessory parts, you must always wear impact-resistant safety goggles. The degree of protection required for each individual task must be evaluated separately in each case.
- Ensure that the workpiece is secure.

### 4.2 Risks associated with items catching/getting entwined

- Wear suitable clothing. Do not wear loose clothing or jewellery. Keep hair, clothing and gloves at a safe distance from the air tool and moving parts. Loose clothing, jewellery or long hair could catch in moving parts. There is a risk of injury in this case.
- Gloves may catch in the rotating drive, cutting or breaking fingers.
- With rotating drive mounts and extensions, rubber or metal-reinforced gloves can easily become caught or entwined.
- Do not wear loose gloves or gloves with torn or worn fingers.
- Never hold the drive, the mount or the drive extension directly.
- Keep your hands away from the rotating drive.

### 4.3 Risks during operation

- When using the air tool, the operator's hands may be exposed to potential risk of crushing, knocks, cuts, abrasions and heat damage. To protect your hands, wear suitable gloves.
- The operator and maintenance staff must be physically capable of handling the size, weight and power output of the air tool.

- Make sure you hold the air tool correctly: Be prepared to counter any standard or unexpected movements, so keep both hands ready.
- Ensure you stand in a safe position and keep your balance at all times.
- It is recommended that you use a suspension device when possible. If this is not an option, it is recommended that you use side grips for air tools with a straight grip and pneumatic tools with a pistol grip. It is always recommended that you use aids to absorb the reaction torque.
- Do not touch rotating parts.
- Avoid accidental operation. If the air supply is interrupted, switch off the air tool using the On/Off switch.
- Only use lubricants that have been recommended by the manufacturer.
- Do not use the tool in confined spaces. Be careful that your hands are not crushed between the air tool and workpiece, especially when unscrewing.
- Wear personal protective equipment and always wear safety glasses. By wearing personal protective equipment such as gloves, protective clothing, a dust mask, non-skid safety shoes, a safety helmet or ear protectors, to suit the type of machine and its use, you reduce the risk of injury. Wearing this equipment is recommended.

#### 4.4 Risks associated with recurring movements

- When working with the air tool, you may experience an uncomfortable sensation in your hands, arms, shoulders, neck or in other body parts.
- Make sure you are in a comfortable position to carry out work with the air tool, check that the tool is held securely, and avoid any awkward positions that make it difficult, for example, to keep your balance. If carrying out work over an extended period, the operator should change position occasionally. This should help to avoid fatigue and any unpleasant sensation.
- If the operator experiences persistent symptoms such as feeling unwell, aches, pains or throbbing, a prickling or burning sensation, loss of hearing, or joint stiffening, these warning signs must not be ignored. The operator should advise the employer of these symptoms and consult a qualified doctor.

#### 4.5 Risks associated with accessory parts

- Disconnect the air tool from the air supply before the accessory or accessory part is secured or replaced.
- Do not touch mounts or accessory parts while working: this would increase the risk of being cut, burned or injured as a result of vibrations.
- Only use accessories that are designed for this machine and that fulfil the requirements and the specifications listed in these operating instructions.
- Only use accessories that are in good condition. If accessories are defective, they may break and be ejected during operation.

#### 4.6 Risks in the workplace

- Slipping, tripping and falling are the main reasons for accidents in the workplace. Pay attention to

- surfaces that may have become slippery as a result of using the air tool, and also watch that the air hose does not cause someone to trip.
- Proceed carefully when working in unfamiliar environments. Power cables and other supply lines may represent a hidden risk.
- The air tool is not designed for use in explosive environments and is not insulated against contact with sources of electric power.
- Ensure that the spot where you wish to work is free of power cables, gas lines or water pipes (e.g. using a metal detector).

#### 4.7 Risks associated with dust and vapours

- The dust and vapours generated when the air tool is used may carry health risks (e.g. cancer, birth defects, asthma and/or dermatitis); it is therefore imperative that a risk assessment is carried out in relation to these risks and that suitable controls are then implemented.
- The risk assessment should take into account both the dust generated while the air tool is used and any existing dust that may be raised during operation.
- The extracted air must be discharged in such a way that the minimum of dust is raised in a dust-filled environment.
- If dust or vapours are generated, the main priority is to control these at the location where they are released.
- All built-in or accessory parts on the air tool that are designed to collect, extract or prevent airborne dust or vapours must be used and maintained in accordance with the manufacturer's instructions.
- Use protective breathing apparatus in accordance with your employer instructions or in accordance with health and safety regulations.

#### 4.8 Risks associated with noise

- Failure to use adequate ear protectors when the noise level is high can result in lasting damage to hearing, hearing loss and other problems, such as tinnitus (ringing, whistling or buzzing in the ear).
- It is vital to carry out a risk assessment in relation to these risks and to implement appropriate control measures that take the risks into account.
- Appropriate risk control measures may include, for example, the use of sound-insulating materials to prevent the knocking sounds that occur on the workpieces.
- Use ear protection in accordance with your employer instructions or in accordance with health and safety regulations.
- The air tool must be operated in accordance with the recommendations provided in these instructions and must be maintained in order to avoid unnecessarily raising the noise level.
- To avoid increasing the noise level unnecessarily, consumables and the accessory must be selected, maintained and replaced in accordance with these instructions.
- The integrated sound absorber must not be removed. You must ensure it is in good working order.

#### 4.9 Risks associated with vibration

- The effects of vibrations can damage nerves and impair blood circulation in the hands and arms.
- Keep your hands away from the pin wrench mounts.
- When working in cold environments, you must wear warm clothing and keep your hands warm and dry.
- If you notice that the skin on your fingers or hands is numb, prickling or turning white, stop working with the air tool immediately, notify your employer and consult a doctor.
- The air tool must be operated in accordance with the recommendations provided in these instructions and must be maintained in order to avoid unnecessarily raising the level of vibration.
- Do not use mounts or extensions that are either worn or badly fitting, since this will most likely result in greater vibration.
- To avoid increasing the level of vibration unnecessarily, consumables and the accessory must be selected, maintained and replaced in accordance with these instructions.
- If possible, you should use sleeve fittings.
- To support the weight of the air tool, use a stand, a clamp or an equaliser whenever possible.
- Hold the air tool firmly but not too tightly using the required manual torque reaction: the risk of vibration is increased when the grip force is higher.

#### 4.10 Additional safety instructions

- Compressed air can cause serious injury.
- When the air tool is not in use, before replacing accessory parts or when carrying out repairs, you must ensure that air supply is shut off, that the air hose is depressurised and that the air tool is disconnected from the compressed air supply.
- Never direct the air jet at yourself or other people.
- Hoses that whip about can cause serious injury. Therefore always check that the hoses and their fixtures are in good condition and that they have not become loose.
- Cold wind should be directed away from the hands.
- If universal swivel couplings (claw couplings) are being used, locking pins must also be used. You should also use whip check hose restraints in case there is a problem with the connection between the hose and air tool or between the hoses themselves.
- Ensure that the maximum pressure specified on the air tool is not exceeded.
- Never carry air tools by the hose.
- Secure the air tool if it is operated in a holder. Loss of control can cause personal injury.

#### 4.11 Additional Safety Instructions

- If applicable, observe any particular health and safety or accident prevention regulations governing the use of compressors and compressed air tools.
- Ensure that the maximum supply pressure specified in the Technical Specifications is not exceeded.
- Do not overload the tool – use it only within the performance range for which it was designed (see “Technical Specifications”).

- Use non-hazardous lubricants. Ensure the workplace is adequately ventilated. If there is a large amount of discharge: Check the air tool and have it repaired if necessary.
- Do not operate the tool unless you are completely focused. You must be alert, pay attention to what you are doing and proceed cautiously when working with an air tool. Never use a tool when you are tired or under the influence of drugs, alcohol or medication. Just one moment's carelessness when using the tool can cause serious injury.
- Make sure your workplace is clean and well lit. Untidy or poorly lit workplaces can cause accidents.
- Keep air tools away from children.
- Do not store the tool outdoors or in damp conditions without protection.
- Protect the air tool, especially the compressed air connection and the control elements from dust and dirt.

Information in these operating instructions is categorised as shown below:



**Danger!** Risk of personal injury or environmental damage.



**Caution.** Risk of material damage

#### 4.12 Symbols on the air tool



Read the Operating Instructions before starting to use the machine.



Wear safety goggles.



Wear ear protectors.



Direction of rotation

## 5. Overview

See page 2.

- 1 Rotation selector switch
- 2 Square attachment for sockets
- 3 Adjusting screw for setting the speed
- 4 Switch (on/off)
- 5 Air outlet
- 6 Compressed air connection with filter
- 7 Plug-in nipple 1/4"

## 6. Operation

### 6.1 Before using the tool for the first time

Insert plug-in nipple (7).

### 6.2 Using the air tool

To benefit from the air tool's full performance, always use compressed air hoses with an inner diameter of at least 9 mm. Tool performance can be significantly impaired if the inner diameter is too small.



 **Caution.** The compressed air line must not contain any water condensation.

 **Caution.** To preserve and extend the service life of this tool, you must ensure that it is regularly maintained with pneumatic oil lubricator. You can do this as follows:

- Use oiled compressed air by fitting an oil-fog lubricator.
- Without an oil-fog lubricator: Manually apply oil every day via the compressed air connection. Use approx. 3-5 drops of pneumatic oil lubricator for each 10 minutes of continuous operation.

If the tool has not been in use for several days, you should manually apply about 5 drops of pneumatic oil lubricator into the compressed air connection.

 **Caution.** Only allow the tool to run at idle speed for a brief period.

1. Place the socket on the square (2) attachment. Ensure that the accessory is fitted securely.
2. You can adjust the speed on the adjusting screw (3).
3. Adjust the speed on the rotation selector switch (1):
  -  = clockwise
  -  = counter-clockwise
4. Adjust the supply pressure (this is measured at the air outlet while the air tool is switched on). For details of the maximum permissible supply pressure, see the Chapter on "Technical Specifications".
5. Connect the air tool to the compressed air supply.
6. To switch on: Press switch (4).  
To switch off: Release switch (4)

## 7. Care And Maintenance

 **Danger!** Disconnect the compressed air connection before carrying out any work.

 **Danger!** Repair and maintenance work other than described in this section should only be carried out by **qualified specialists**.

- Carry out regular maintenance to ensure the safety of the air tool.
- Check that all screw fittings are seated securely, and tighten if necessary.
- Clean the filter in the compressed air connection at least once a week.
- It is recommended that you install a pressure reducer with an air-water separator and lubricator upstream of the air tool.
- If a large amount of air or oil is escaping, check the air tool and have it maintained if necessary. (see Section 9.)
- Check the rotational speed regularly and after every use. Also carry out a simple check on vibration emission.
- Avoid contact with dangerous substances that have collected on the tool. Wear suitable personal protective equipment and take appropriate meas-

ures to remove any dangerous substances before maintenance.

## 8. Accessories

Use only genuine Metabo accessories.

Only use accessories that are designed for this air tool and that fulfil the requirements and the specifications listed in these operating instructions.

For a complete range of accessories, see [www.metabo.com](http://www.metabo.com) or the catalogue.

## 9. Repairs

 **Danger!** Repairs to air tools must only be carried out by qualified specialists, using original Metabo spare parts!

If you have Metabo air tools that require repairs, please contact your Metabo service centre. For addresses see [www.metabo.com](http://www.metabo.com).

You can download spare parts lists from [www.metabo.com](http://www.metabo.com).

## 10. Environmental Protection

Observe national regulations on environmentally compatible disposal and on the recycling of disused air tools, packaging and accessories. You must not cause risks to people or the environment.

Packaging materials must be disposed of according to their labelling in accordance with municipal guidelines. Further information can be found at [www.metabo.com](http://www.metabo.com) in the "Service" section.

## 11. Technical specifications

Explanatory notes on the specifications on page 3. Changes due to technological progress reserved.

$V_1$	=	Air requirement
$p_{max.}$	=	maximum permissible supply pressure
$n_0$	=	Rotational speed
H	=	Square attachment
S	=	max. screw size
$T_{max, R}$	=	Clockwise torque
$T_{max, L}$	=	Counter-clockwise torque
$d_i$	=	Hose diameter (inner)
C	=	Connecting thread
A	=	Dimensions: Length x Width x Height
m	=	Weight

The technical specifications quoted are subject to tolerances (in compliance with the relevant valid standards).

### Emission values

Using these values, you can estimate the emissions from this tool and compare these with the values emitted by other tools. The actual values may be higher or lower, depending on the particular application and the condition of the tool or accessory. In estimating the values, you should also include work breaks and periods of low use. Based on the estimated emission values, specify protec-

tive measures for the user - for example, any organisational steps that must be put in place.

Vibration (acceleration value, frequency-weighted according to EN 28927):

$a_h$  = Vibration emission level

$K_h$  = Measurement uncertainty (vibration)

Sound level (EN ISO 15744):

$L_{pA}$  = Sound pressure level

$L_{WA}$  = Acoustic power level

$K_{pA}$ ,  $K_{WA}$  = Measurement uncertainty



**Wear ear protectors!**