

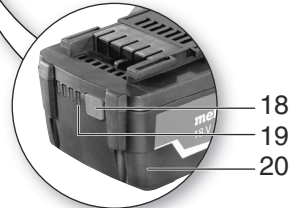

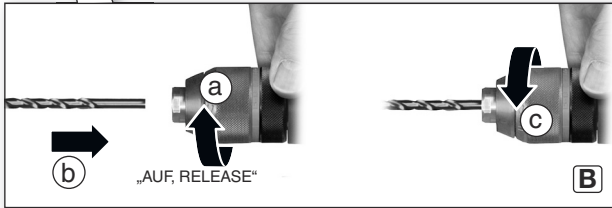

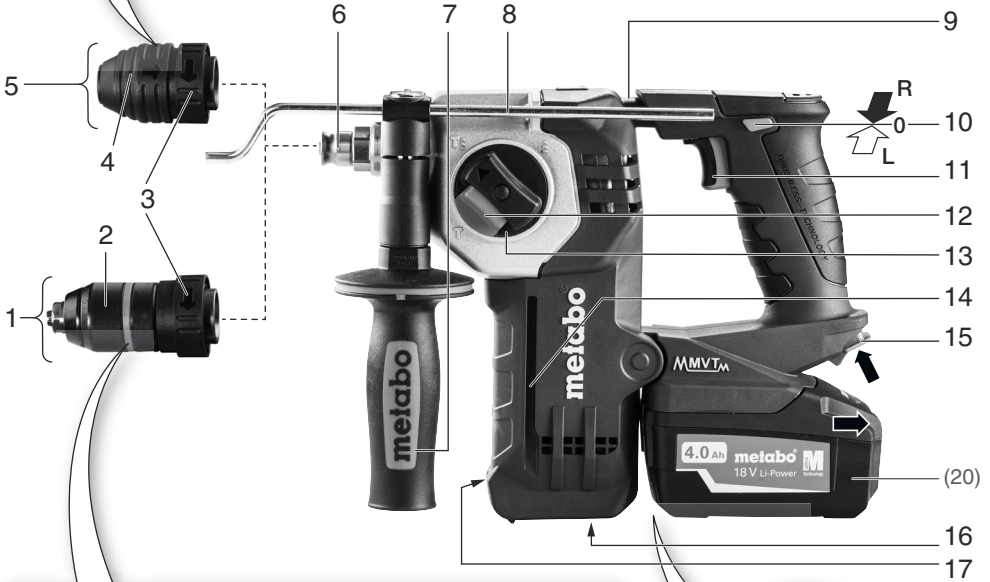

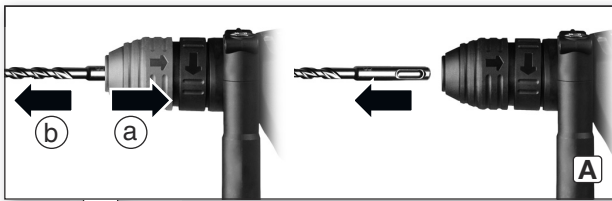



KHA 18 LTX BL 24 Quick

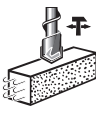

en Operating Instructions 4
fr Mode d'emploi 9

es Instrucciones de manejo 15



			<h2 style="text-align: center;">KHA 18 LTX BL 24 Quick</h2> <p style="text-align: center;">Serial Number: 00211..</p>
	U	V	18
	n_1	/min rpm	0 - 1200
	n_2	/min rpm	1200
	SDS-plus		✓
	\varnothing max.	mm (in)	24 (1)
	s max.	/min bpm	4500
	W(EPTA (05/2009))	J	2,2
	\varnothing max.	mm (in)	68 (2 ⁵ / ₈)
	\varnothing max.	mm (in)	25 (1)
	\varnothing max.	mm (in)	13 (¹ / ₂)
	m	kg (lbs)	3,4 (7 ¹ / ₂)
	D	mm (in)	50 (1 ³¹ / ₃₂)
	$a_{h,HD}/K_{h,HD}$	m/s ²	10,5 / 1,5
	$a_{h,Cheq}/K_{h,Cheq}$	m/s ²	8,6 / 1,5
	L_{pA}/K_{pA}	dB (A)	91 / 3
	L_{WA}/K_{WA}	dB (A)	102 / 3

Metabowerke GmbH,
Postfach 1229
Metabo-Allee 1
D-72622 Nuertingen
Germany

Operating Instructions

1. Specified Use

With the appropriate accessories, the machine is suitable for work with hammer drill bit and chisels in concrete, stone and similar materials and with core cutters in tiles and similar materials, as well as for non-impact drilling into metal, wood etc. and for driving screws.

The user bears sole responsibility for any damage caused by improper use.

Generally accepted accident prevention regulations and the enclosed safety information must be observed.

2. General safety instructions



For your own protection and for the protection of your electrical tool, pay attention to all parts of the text that are marked with this symbol!



WARNING – Reading the operating instructions will reduce the risk of injury.

Pass on your electrical tool only together with these documents.

General Power Tool Safety Warnings



WARNING – Read all safety warnings and instructions. Failure to follow the warnings and instructions may result in electric shock, fire and/or serious injury.

Save all warnings and instructions for future reference! The term "power tool" in the warnings refers to your mains-operated (corded) power tool or battery-operated (cordless) power tool.

2.1 Work area safety

- Keep work area clean and well lit.** Cluttered or dark areas invite accidents.
- Do not operate power tools in explosive atmospheres, such as in the presence of flammable liquids, gases or dust.** Power tools create sparks which may ignite the dust or fumes.
- Keep children and bystanders away while operating a power tool.** Distractions can cause you to lose control.

2.2 Electrical safety

- Power tool plugs must match the outlet. Never modify the plug in any way. Do not use any adapter plugs with earthed (grounded) power tools.** Unmodified plugs and matching outlets will reduce risk of electric shock.
- Avoid body contact with earthed or grounded surfaces, such as pipes, radiators, ranges and refrigerators.** There is an increased risk of electric shock if your body is earthed or grounded.

c) **Do not expose power tools to rain or wet conditions.** Water entering a power tool will increase the risk of electric shock.

d) **Do not abuse the cord. Never use the cord for carrying, pulling or unplugging the power tool. Keep cord away from heat, oil, sharp edges or moving parts.** Damaged or entangled cords increase the risk of electric shock.

e) **When operating a power tool outdoors, use an extension cord suitable for outdoor use.** Use of a cord suitable for outdoor use reduces the risk of electric shock.

f) **If operating a power tool in a damp location is unavoidable, use a residual current device (RCD) protected supply.** Use of an RCD reduces the risk of electric shock.

2.3 Personal safety

a) **Stay alert, watch what you are doing and use common sense when operating a power tool. Do not use a power tool while you are tired or under the influence of drugs, alcohol or medication.** A moment of inattention while operating power tools may result in serious personal injury.

b) **Use personal protective equipment. Always wear eye protection.** Protective equipment such as dust mask, non-skid safety shoes, hard hat, or hearing protection used for appropriate conditions will reduce personal injuries.

c) **Prevent unintentional starting. Ensure the switch is in the off-position before connecting to power source and/or battery pack, picking up or carrying the tool.** Carrying power tools with your finger on the switch or energising power tools that have the switch on invites accidents.

d) **Remove any adjusting key or wrench before turning the power tool on.** A wrench or a key left attached to a rotating part of the power tool may result in personal injury.

e) **Do not overreach. Keep proper footing and balance at all times.** This enables better control of the power tool in unexpected situations.

f) **Dress properly. Do not wear loose clothing or jewellery. Keep your hair, clothing and gloves away from moving parts.** Loose clothes, jewellery or long hair can be caught in moving parts.

g) **If devices are provided for the connection of dust extraction and collection facilities, ensure these are connected and properly used.** Use of dust collection can reduce dust-related hazards.

2.4 Power tool use and care

a) **Do not force the power tool. Use the correct power tool for your application.** The correct power tool will do the job better and safer at the rate for which it was designed.

b) **Do not use the power tool if the switch does not turn it on and off.** Any power tool that cannot be controlled with the switch is dangerous and must be repaired.

- c) **Disconnect the plug from the power source and/or the battery pack from the power tool before making any adjustments, changing accessories, or storing power tools.** *Such preventive safety measures reduce the risk of starting the power tool accidentally.*
- d) **Store idle power tools out of the reach of children and do not allow persons unfamiliar with the power tool or these instructions to operate the power tool.** *Power tools are dangerous in the hands of untrained users.*
- e) **Maintain power tools. Check for misalignment or binding of moving parts, breakage of parts and any other condition that may affect the power tool's operation. If damaged, have the power tool repaired before use.** *Many accidents are caused by poorly maintained power tools.*
- f) **Keep cutting tools sharp and clean.** *Properly maintained cutting tools with sharp cutting edges are less likely to bind and are easier to control.*
- g) **Use the power tool, accessories and tool bits etc. in accordance with these instructions, taking into account the working conditions and the work to be performed.** *Use of the power tool for operations different from those intended could result in a hazardous situation.*

2.5 Battery tool use and care

- a) **Recharge only with the charger specified by the manufacturer.** *A charger that is suitable for one type of battery pack may create a risk of fire when used with another battery pack.*
- b) **Use power tools only with specifically designated battery packs.** *Use of any other battery packs may create a risk of injury and fire.*
- c) **When battery pack is not in use, keep it away from other metal objects, like paper clips, coins, keys, nails, screws or other small metal objects, that can make a connection from one terminal to another.** *Shorting the battery terminals together may cause burns or a fire.*
- d) **Under abusive conditions, liquid may be ejected from the battery; avoid contact. If contact accidentally occurs, flush with water. If liquid contacts eyes, additionally seek medical help.** *Liquid ejected from the battery may cause irritation or burns.*

2.6 Service

- a) **Have your power tool serviced by a qualified repair person using only identical replacement parts.** *This will ensure that the safety of the power tool is maintained.*

3. Special Safety Instructions

Wear ear protectors. Exposure to noise can cause hearing loss.

Use the additional handle supplied with the tool. Loss of control can cause personal injury.

Hold tool by insulated gripping surfaces when performing an operation where the cutting accessory may contact hidden wiring. If the

cutting accessory contacts a "live" wire, exposed metal parts of the electrical tool may become "live" and give the operator an electric shock.

Work only with the additional handle correctly installed.

Always hold the machine with both hands using the handles provided, stand securely and concentrate.

Always wear protective goggles, gloves, and sturdy shoes when working with this tool.

Ensure that the spot where you wish to work is free of **power cables, gas lines or water pipes** (e.g. by using a metal detector).

Do not touch the rotating tool!

Secure the workpiece against slipping, e.g. with the help of clamping devices.

Remove chips and similar material only when the machine is at a standstill.

Caution when carrying out hard screwdriving (driving of screws with either a metric or an imperial thread into steel)! The head of the screw may be ripped off or high restoring torques may occur on the handle.

S-automatic safety clutch: If the tool jams or catches, the power supply to the motor is restricted. Due to the strong force which can arise, always hold the machine with both hands using the handles provided, stand securely and concentrate.

A damaged or cracked additional handle must be replaced. Never operate a machine with a defective additional handle.

LED light (17): do not observe the LED radiation directly with optical instruments.

Remove the battery pack from the machine before any adjustments, conversions or servicing are performed.

 Protect battery packs from water and moisture!

 Do not expose battery packs to naked flame!

 Do not use faulty or deformed battery packs!

Do not open battery packs!

 Do not touch or short-circuit battery packs!

 Slightly acidic, flammable fluid may leak from defective li-ion battery packs!

 If battery fluid leaks out and comes into contact with your skin, rinse immediately with plenty of water. If battery fluid leaks out and comes into contact with your eyes, wash them with clean water and seek medical attention immediately.

If the machine is defective, remove the battery pack from the machine.

Transport of li-ion battery packs:

The shipping of li-ion battery pack is subject to laws related to the carriage of hazardous goods (UN 3480 and UN 3481). Inform yourself of the currently valid specifications when shipping li-ion battery packs. If necessary, consult your freight forwarder. Certified packaging is available from Metabo.

Only send the battery pack if the housing is intact and no fluid is leaking. Remove the battery pack from the machine for sending. Prevent the contacts from short-circuiting (e.g. by protecting them with adhesive tape).

Additional Warnings:

⚠ WARNING Some dust created by power sanding, sawing, grinding, drilling, and other construction activities contains chemicals known to cause cancer, birth defects or other reproductive harm. Some examples of these chemicals are:

- Lead from lead-based paints,
- Crystalline silica from bricks and cement and other masonry products, and
- Arsenic and chromium from chemically treated lumber.

Your risk from these exposures varies, depending on how often you do this type of work. To reduce your exposure to these chemicals: work in a well ventilated area, and work with approved safety equipment, such as those dust masks that are specially designed to filter out microscopic particles.

Symbols on the tool:

-  Class II Construction
- V volts
- A amperes
- Hz hertz
- W watts
- BPM beat per minute
- direct current
- n₀ no-load speed
- rpm revolutions per minute
- .../min ... revolutions per minute

4. Overview

See page 2.

- 1 Keyless chuck *
- 2 Keyless chuck sleeve *
- 3 Chuck lock
- 4 Tool lock
- 5 SDS chuck
- 6 Spindle
- 7 Additional handle
- 8 Depth stop
- 9 Metabo VibraTech (MVT)
- 10 Rotation selector switch
- 11 Trigger switch
- 12 Lock
- 13 Switch button (for changing the operating mode)
- 14 Guide groove for the dust extraction ISA 18 LTX
- 15 Battery pack release button
- 16 Rubber cover for dust protection of the power supply for the dust extraction ISA 18 LTX
- 17 LED light to illuminate the workplace
- 18 Capacity indicator button
- 19 Capacity and signal indicator

20 Battery pack

* depending on model

5. Initial Operation

5.1 Assembly of the additional handle

 For safety reasons, always use the additional handle supplied.

Open the clamping ring by turning the additional handle (7) anticlockwise. Push the additional handle onto the collar of the machine. Insert the depth stop (8). Securely tighten the additional handle at the angle required for the application.

5.2 Battery pack

Charge the battery pack (20) before use.

Recharge the battery pack if performance diminishes.

The ideal storage temperature is between 10°C and 30°C.

Li-Ion battery packs “Li-Power, LiHD“ have a capacity and signal indicator (19):

- Press the button (18); the LEDs indicate the charge level.
- The battery pack is almost flat and must be recharged if one LED is flashing.

5.3 Removing and inserting the battery pack

Removing:

Press the battery pack release (15) button and remove the battery pack (20).

Inserting:

Slide in the battery pack (20) until it engages.

6. Use

6.1 Depth Stop Setting

Loosen the additional handle (7). Set depth stop (8) to the desired drilling depth and retighten additional handle. (7)



6.2 Switching On and Off

To start the machine, press the trigger (11). The speed can be changed at the trigger.

Release the trigger (11) to switch off.

6.3 Operating mode selection



Press (12) the lock and turn the thumbwheel (13).



-  Drilling
-  Hammer drilling (only set if using (5) SDS chuck)
-  Chiselling (only set if using SDS chuck (5))

 When a chisel is fitted, only operate the machine in the chiselling operating mode .

 Avoid levering with the machine when a chisel is fitted.

6.4 Setting chisel position

- Insert the chisel.
- Turn the switch button (13) in such a way that it is between setting  and setting .
- Turn the chisel to the required position.
- Turn the switch button (13) in position .
- Turn the chisel until it engages.

 When a chisel is fitted, only operate the machine in the chiselling operating mode .

6.5 Selecting the direction of rotation

 Do not activate the direction switch (10) unless the motor has completely stopped.

Selecting the direction of rotation:

- R = Clockwise (for drilling, hammer drilling, chiselling, inserting screws)
- L = Counter-clockwise (for extracting screws)
- 0 = Centre position: with the transporting safety device engaged (switch-on lock)

6.6 Drill chuck change

 When changing chucks, make sure that the spindle is clean. (6) Apply a light coating of grease to the spindle. (Special grease: Order No.: 6.31800)

 Only attach the Metabo chuck provided.

Removing the chuck:

See page 2, fig. C.

- Turn chuck lock (3) as far as it will go (a) in the direction indicated by the arrow, and remove chuck (b).

Replacing the chuck:

See page 2, fig. D.

- Place chuck onto spindle (6) (a).
- Turn chuck lock (3) in the direction indicated by the arrow (b) until chuck slides fully onto the spindle. Then release the chuck lock.
- Check to see that the chuck is properly seated.

Note: To prevent the spindle from turning while chucks are being changed, set the switch button (13)  to chiselling mode.

6.7 Tool change with SDS chuck

 Before fitting, clean tool shank and apply special grease (accessories order no. 6.31800)! Use only SDS-Plus tools.

Inserting tools:

- Turn tool and insert until it engages. The tool is locked automatically.

Removing the tool:

See page 2, fig. A.

- Pull tool lock (4) backwards in direction indicated by arrow (a) and remove tool (b).

6.8 Tool change with keyless chuck

Use the keyless chuck when non-impact drilling in metal, wood etc. and driving screws.

Tighten the tool (see page 2, fig. B):

Turn sleeve (2) in direction "AUF, RELEASE" (a). Insert tool as deeply as possible (b) and turn sleeve in the opposite direction, until any perceptible mechanical resistance is overcome (c). **Caution!**

The chuck is not yet fully tightened!

Keep turning the sleeve (**it must "click" when turning**) until it cannot be turned any further - **only now** is the tool **securely** clamped.

With a soft tool shank, retightening may be required after a short period of operation.

Note: The grating sound that may be heard after the drill chuck is opened is purely functional; it is stopped by turning the sleeve in the opposite direction.

If the chuck is extremely tight: remove the battery pack from the machine. Hold the drill chuck at the drill chuck head using an open-end spanner and turn the sleeve (2) vigorously in the direction "OPEN, RELEASE".

6.9 Metabo VibraTech (MVT)

For reduced vibrations and less stress on the hands.

Always apply a moderate amount of pressure to the handle when pushing down the machine and do not force. Vibrations are reduced most effectively at the central position (9).

7. Maintenance, cleaning

- Ventilation slits:

Clean the ventilation slits on the machine occasionally.

- Remove the **battery pack** periodically and wipe the contact area of the battery pack and machine with a dry cloth and remove drilling dust.

- Always keep the **spindle (6)** clean and apply a light coating of grease. (Special grease: Order No.: 6.31800)

- Keyless chuck (1) cleaning:

After prolonged use, hold the chuck vertically, with the opening facing down, and fully close it and open it several times. The dust collected falls from the opening. The application of cleaning spray to the jaws and jaw openings at regular intervals is recommended.

8. Accessories

Only use original Metabo battery packs and Metabo accessories.

Use only accessories that fulfil the requirements and specifications listed in these operating instructions.

Fit accessories securely. If the machine is operated in a holder: secure the machine well. Loss of control can cause personal injury.

Batter chargers: ASC Ultra, ASC 30-36, etc.

Battery packs with different capacities. Only use battery packs with voltage suitable for your power tool.

en ENGLISH

Order no.: 6.25346 ... 3.5 Ah (LiHD)

Order no.: 6.25342 ... 5.5 Ah (LiHD)

Order no.: 6.25345 ... 7.0 Ah (LiHD)
etc.

Order no.: 6.25591 4 Ah (Li-Ion)

Order no.: 6.25592 5.2 Ah (Li-Ion)
etc.

Integrated dust extraction ISA 18 LTX 24

Order no.: 6.31341

For a complete range of accessories, see
www.metabo.com or the catalogue.

$K_{h,HD/Cheq}$ = Uncertainty (vibration)

Typical A-effective perceived sound levels::

L_{pA} = Sound pressure level

L_{WA} = Acoustic power level

K_{pA} , K_{WA} = Uncertainty

During operation the noise level can exceed
80 dB(A).



Wear ear protectors!

9. Repairs

Repairs to electrical tools must be carried out by
qualified electricians ONLY!

If you have Metabo electrical tools that require
repairs, please contact your Metabo service centre.
For addresses see www.metabo.com.

You can download spare parts lists from
www.metabo.com.

10. Environmental Protection

Do not allow battery packs to come into contact with
water!

Before disposal, discharge the battery pack in the
power tool. Prevent the contacts from short-circu-
iting (e. g. by protecting them with adhesive tape).

11. Technical Specifications

Explanation of details on page 3. Subject to
changes serving technical progress.

U = Voltage of battery pack

n_1 = No-load speed

n_2 = Load speed

$d_{\text{dia,max}}$ = Maximum drill diameter

S_{max} = Maximum impact rate

W = Single impact force

m = Weight with smallest battery pack

D = D =Collar diameter

The technical specifications quoted are subject to
tolerances (in compliance with the relevant valid
standards).



Emission values

Using these values, you can estimate the
emissions from this power tool and compare these
with the values emitted by other power tools. The
actual values may be higher or lower, depending on
the particular application and the condition of the
tool or power tool. In estimating the values, you
should also include work breaks and periods of low
use. Based on the estimated emission values,
specify protective measures for the user - for
example, any organisational steps that must be put
in place.

Vibration total value (vector sum of three directions)
determined in accordance with EN 60745:

$a_{h, HD}$ = Vibration emission value (hammer
drilling into concrete)

$a_{h, Cheq}$ = Vibration emission value (chiselling)